

## TOOLS



5 min

## PARTS

x1

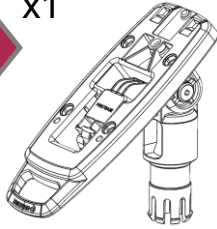

x1



x1

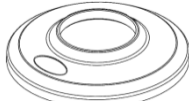

1

Remove original cover from stand

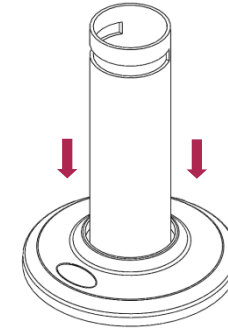
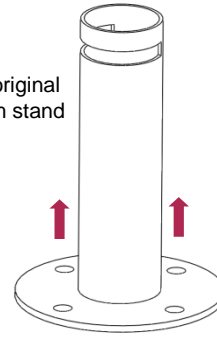

Slot new cover on to stand.

**CHECK**  
Ensure logo on cover is facing forward. Must line up with slot in stand

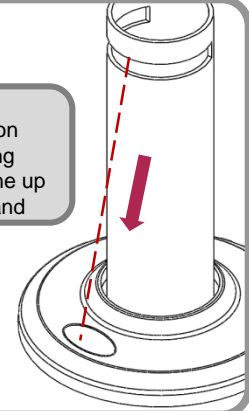

2

**IMPORTANT !!**  
Part **MUST** be fitted with feature on plug facing rear of pole

REAR

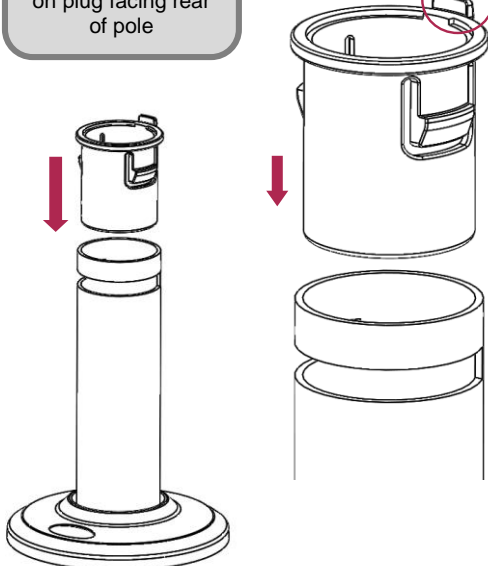

Position very important!  
Check before fitting

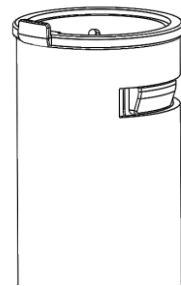

Must look like this

3

Slot Flexipole Connect into pole until click

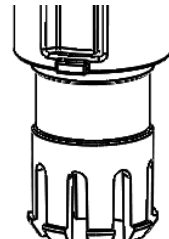

CLICK !!

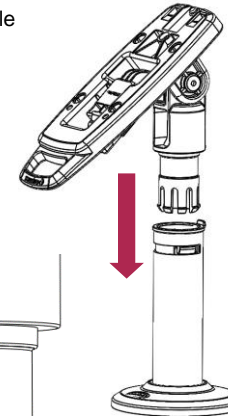

**CHECK**  
Features **MUST NOT** be aligned or plinth will not slot into pole correctly

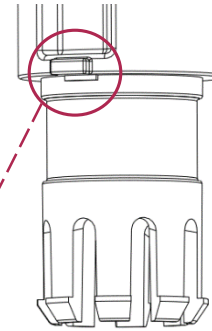

Plinth rotates in pole

